



DTL137

You can rely on Defy. To simplify.

TOP LOADER Automatic Washing Machine

Users Manual

Record in the space below the listed information for future reference.

SERIAL NUMBER.....

DATE OF PURCHASE.....

PURCHASED FROM.....

.....

The manufacturer strives for continuous improvement. For this reason, the text and illustrations in this manual are subject to change without notice.

Contents

Introduction	3
Important safety instructions	4
Know your washing machine	6
Accessories	6
Installation	7
Control panel	9
Initial use	10
Washing procedure & programme selection	11
Using detergents, softeners, & bleach	13
General operating procedures	14
Cleaning the filters	14
Wash programme guide	16
Technical specifications	16
Owners responsibility	17
Things to be done for energy saving	17
Disposing of the old washing machine	17
Trouble shooting	18
Service Centres	19
Warranty	20



Values stated on the machine labels or in the documentation accompanying it are obtained in laboratory conditions in accordance with the relevant standards. Depending on operational and environmental conditions of the machine, these values may vary.

1 Introduction

Dear Customer,

Your new Defy top loader washing machine was manufactured in a state of the art facility and has passed the strictest quality control procedures.

Please read this manual carefully before using your washing machine for the first time and then store it within easy reach for future reference.

This manual will provide you with information on how to operate and care for your washing machine to gain the maximum benefit from it.

We trust you will enjoy years of trouble free use.

EXPLANATION OF SYMBOLS



Important information



Warning—Hazardous situations



Warning—Electric shock



PLEASE REGISTER YOUR PRODUCT AT

www.defy.co.za

DEFY APPLIANCES (PTY) LTD

P.O.BOX 12004

JACOBS

DURBAN

4026

SOUTH AFRICA

2 Important safety instructions



General safety

- **This washing machine is not intended for use by persons (including children) with reduced physical, sensory or mental capabilities or lack of experience and knowledge unless they have been given supervision or instruction concerning the use of the washing machine by a person responsible for their safety.**
- **Children should be supervised to ensure that they do not play with the washing machine.**
- Never place the washing machine on a carpeted floor. Lack of airflow beneath the machine could cause overheating.
- In case of a malfunction or maintenance work, disconnect the washing machine from the electrical mains immediately. Repairs must only be made by a qualified technician.
- Before washing, check all clothes for loose buttons and tears. Check pockets for coins, pins or other small articles. Close zips and fasteners. Wash small articles inside a pillow case.
- Do not wash clothes stained with or soaked in petrol, thinners, kerosene, vegetable oil or any other flammable liquids. Nor should any of these liquids be added to the wash water as they constitute a fire hazard or there may be a risk of an explosion.
- Only use the machine for washing fabrics. Do not attempt to wash plastic leather or fibreglass. Sort and separate clothes by fabric, colour and degree of dirt.
- Use detergents, softeners and supplements suitable for top loading automatic washing machines only.
- Always unplug the machine from the wall socket when it requires cleaning or service. Only permit qualified persons to repair or install parts in the washer.
- **Do not use water which is hotter than 50 degrees Celsius as this may deform plastic parts of the machine, which could result in injury, electric shock or water leakage.**
- The water supply and draining hoses must be securely fastened and remain undamaged to prevent water leakage.
- Check the water supply hose connection by turning on the water before washing and ensure there is no water leakage.
- Follow the instructions on the textile tags and on the detergent package.
- Installation and repairing procedures must be carried out by an Authorized Service Agent. Repairs carried out by incompetent persons create a user risk: There may be a risk of accidental fire. If the washer operates abnormally, it may cause an injury. The Manufacturer shall not be held liable for damages that may arise from procedures carried out by unauthorized persons.
- **Do not expose the machine to any type of flame or put cigarettes or any volatile substances on the machine top.** The machine may catch fire or the machine may be deformed due to its large number of plastic components.
- **Do not install the machine in a bathroom or very humid place.**
Doing so may cause a malfunction or result in a short circuit and there is a risk of an electric shock.
- **Never wash the machine by spreading or pouring water onto it!** Avoid spraying water on to the control panel and back of the machine. There is the risk of an electric shock, and it may cause the machine to malfunction.

	<p>Warning! Never reach into or put your hands into the wash/spin tub whilst the machine is operating. If you reach into the wash/spin tub serious injury could result. Wait until all motion stops.</p>
	<p>Warning! If the wash/spin tub does not stop within 15 seconds after the washer lid is opened, turn off the washer immediately and call an authorised service person.</p>
	<p>Warning! The machine must be unplugged during installation, maintenance, cleaning and repairing procedures to avoid the risk of an electric shock.</p>

- **Do not wash, rinse or spin water proof fabrics such as sleeping bags, raincoats, car covers etc.** Washing these types of materials may lead to injury through abnormal vibration during spinning or damage may result to the washing machine, wall, floor and clothes.
- Keep hands and feet away from the bottom of the washing machine when it is in use to avoid the risk of injury.
- Do not stand on the washing machine or place weight on the washing machine. Damage to the washing machine may result and there is a risk of personal injury.
- Turn off the water supply at the tap when the washing machine is not in use to minimise the risk of damage that could arise from water leakage. Unplug the washing machine if it is not going to be used for a long period of time.

Intended use

- The washing machine must only be used domestically and for the purposes for which it was designed.

Children's safety

- Electrical products are dangerous for children. Keep children away from the washing machine when it is in use. Use child lock to prevent children from tampering with the washing machine controls.
- Store all detergents and additives in a safe place away from the reach of the children by closing the cover of the detergent container or sealing the detergent package.
- Do not allow children to play on or in the machine. If a child accidentally falls into the wash/spin tub, serious injury could occur. Close the lid when leaving the room where the machine is located.
- Keep children away from the washing machine and keep boxes or steps well away from the washing machine to prevent children from stepping up and accessing the controls, lid and wash tub of the washing machine.

Transportation of the machine

1. Unplug the machine before transporting it.
2. Remove water drain hose and water supply hose connections.

3. Drain all remaining water from the machine.

Unpacking

- Remove all packaging and dispose of it in a responsible manner. Plastic bags should be cut up to prevent children playing with them and accidentally suffocating.
- Open the wash-tub lid and remove all the accessories stored in the wash tub.
- Do not attempt to operate the machine while any of the packaging is still in place.

Electrical connection

- The washing machine must be earthed and the manufacturer and seller do not accept responsibility for any damage due to incorrect electrical connection.
- Connection must comply with national regulations.
- The washing machine should be plugged into a 16 Amp, 230-240V~50Hz earthed 3 pin wall socket. If the current value of the fuse or breaker in the house is less than 16 Amps, have a qualified electrician install a 16 Amp fuse.

Ensure that the power plug and power cord are properly connected.

- Never touch the plug with wet hands!
- Never unplug by pulling on the cable, always pull out by grabbing the plug.
- Do not operate a damaged washing machine. Consult with your nearest DEFY service centre should you have any concerns.
- If the power cable is damaged, it must be replaced by the manufacturer, after sales service or a similarly qualified person.
- Never plug the washing machine into the wall socket during installation. Death or serious injury may result.
- For safety reasons, the wall socket and the plug should be accessible after installation.
- Do not make connections via extension cables or multi-plugs.







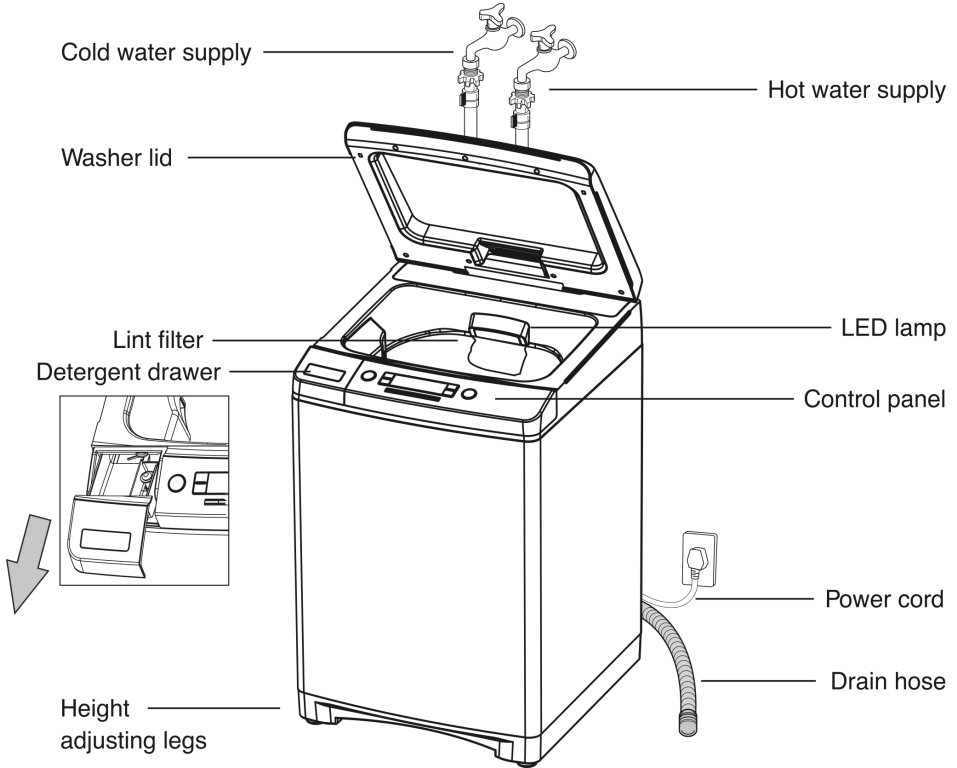

Warning: Installation and electrical connections of the machine must be carried out by an Authorized Service Agent. The Manufacturer shall not be held liable for damages that may arise.

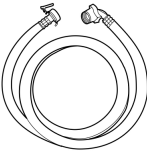
3 Know your washing machine

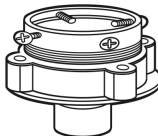





Accessories

Water supply hoses (Two)	Drain hose	Water hose fixer (Two)	User manual
			

	The manufacturer strives for continuous improvement. For this reason, technical specifications, text and illustrations in this manual are subject to change without notice.
	Figures in this manual are schematic and may not match your machine exactly.
	Values stated on the machine labels or in the documentation accompanying it are obtained in laboratory conditions in accordance with the relevant standards. Depending on operational and environmental conditions of the machine, these values may vary.

4 Installation

Installation and electrical connections of the machine must be carried out by an Authorized Service Agent. Review information in the user manual and ensure that the electricity, water supply and water drainage systems are appropriate before calling an Authorized Service Agent. If they are not, call a qualified technician and plumber to have any necessary arrangements carried out.

	Preparation of location, electrical, tap water and waste water installations of the machine are the customer's responsibility.
	Warning: Installation and electrical connections of the machine must be carried out by an Authorized Service Agent. The Manufacturer shall not be held liable for damages that may arise.
	Warning: Prior to installation, visually check if the machine has any defects on it. If so, do not have it installed. A damaged machine is a safety risk.
	Ensure that the water inlet, discharge hoses and power cable are not folded, pinched or crushed, during or after installation or cleaning procedures.

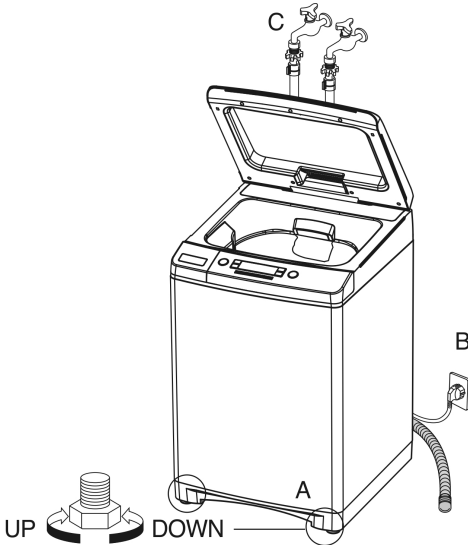

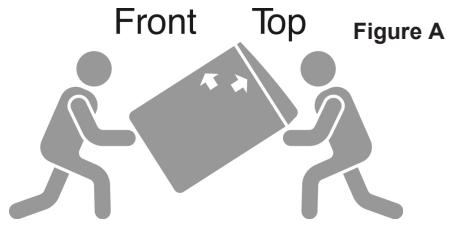

Before moving the machine, take note of **figure A** on how to carry the machine.



Appropriate installation location



- Place the machine on a rigid floor that has sufficient load carrying capacity.
- Choose a well ventilated dry location out of direct sunlight.
- Do not place the machine on the power cable.
- Do not install the machine at places where the temperature may fall below 0°C.
- Place the machine at least 10 mm away from the edges of other furniture.
- Hot and cold water taps should be located within 1 metre of the inlet valves.

Adjust the adjustable leg A of the machine if necessary to ensure that the machine is level. The maximum permissible inclination of the ground surface is 2 degrees. A machine that is not levelled and is unstable will vibrate and generate excessive noise.

	Warning: Do not place the machine on a rug or carpeted floor as this may restrict ventilation openings at the bottom of the machine.
	Warning: Do not use old or used water inlet hoses on the new machine. It may cause stains on your laundry.

Connecting the water supply

1. Check that the sealing washers are correctly seated.
2. Attach the curved end of the water supply hose to the inlet valve of the machine, tighten the coupling nuts by hand. Never use a tool when tightening the nuts.
3. Attach the straight end of the hose to the tap. Tighten the coupling nuts by hand.
4. Open the taps fully after completing the hose connection and check for water leaks. If there are any leaks, turn off the tap and remove the nut. Retighten the nut carefully after checking the seal. To prevent water leakages and damages caused by them, keep the taps closed when the machine is not in use.

	Warning: Ensure that the cold and hot water connections are made correctly when installing the machine.
	Warning: Do not use water that is hotter than 50°C

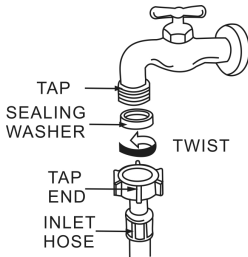

Fitting the water supply hose to the washing machine:

Hold the hose and turn the nut clockwise. Firmly hand tighten the nut.

To remove the hose, switch off the tap and then turn the nut counter clockwise.

Fitting the drain hose

1. Compress the two ears of the drain hose clamp with your hands and connect the drain hose to the pump outlet. Fix the clamp in place.

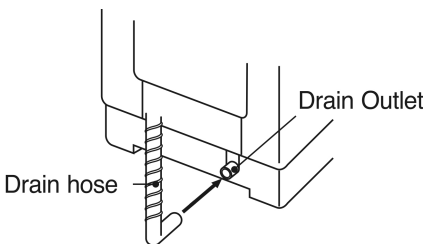

The hose should not be twisted, bent or squeezed shut and must not be stepped on.

2. Pull the outlet end of the drain hose upwards and fix it with the hose clamp on the rear of the washing machine cabinet.
3. When the machine is not in use, hang the drain hose on the recess on the right side of the machine cabinet. When the machine is in operation, place the outlet end of the drain hose into the sink or a dedicated drainage outlet.

Laundry tub drain system

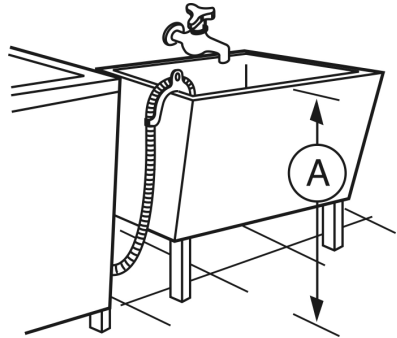

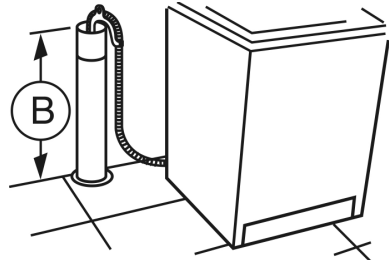

	CAUTION: Ensure the height of the drain hose is not less than 860 mm and not more than 1300 mm from the bottom of the washer. (See A).
---	---

Standpipe drain system



The hose should not be twisted, bent or squeezed shut and must not be stepped on.

	CAUTION: Ensure the height of the drain hose is not less than 860 mm and not more than 1300 mm from the bottom of the washer. (See B).
	Warning: The drain hose must be securely fitted for good water flow and to avoid risk of flooding or injury.

5 Control panel

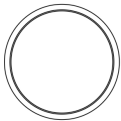



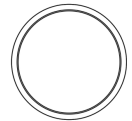



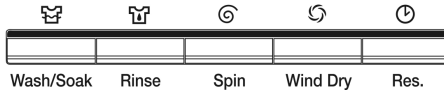



Power



Start / Pause



 Power	<ul style="list-style-type: none"> • Press this button to turn the power 'ON' or 'OFF'!
 Water Temp.	<ul style="list-style-type: none"> • Press to choose the water temperature to be supplied. • As the button is pressed, water temperature will be repeated. COLD → COLD + HOT → HOT • The single valve model has no water temperature select button.
 Water Level	<ul style="list-style-type: none"> • Press to adjust the amount of supplied water to suit the amount of laundry to be washed. • As the button is pressed, the water level is selected Med → High → Low → E.Low
 Wash/Soak	<ul style="list-style-type: none"> • Press to adjust the washing time and soak time. • As the button is pressed, the washing time will be repeated as follows; 18 → 30 → SOAK → 0 → 6 → 10 → 15
 Rinse	<ul style="list-style-type: none"> • Press to adjust the number of times to rinse. • As the button is pressed, the rinsing times will be repeated as follows; 3 Rinse → 4 Rinse → 1 Rinse → 2 Rinse
 Spin	<ul style="list-style-type: none"> • Press to adjust the spinning time. • As the button is pressed, the spinning time will be repeated as follows; 3 → 5 → 7 → 9 → 0 → 1
 Programme	<ul style="list-style-type: none"> • Press to select the fully-automatic programmes. • As the button is pressed, the programmes will be repeated as follows; Fuzzy → Economy → Delicate → Blanket → Cotton Quick → Tub Clean
 Wind Dry	<ul style="list-style-type: none"> • Press to adjust the wind-drying time after spin. • As the button is pressed, the wind-drying time will be repeated as follows; 10 → 20 → 30 → 40
 Air Bubble Up	<ul style="list-style-type: none"> • Press to select the Air Bubble Up programmes. • As the button is pressed, the programmes will be repeated as follows; Gym Shoes → Under Wear → School Bag → Sports Wear
 Start / Pause	<ul style="list-style-type: none"> • Press to start the washer operation or to temporarily stop the operation. • When you want to change a programme during operation; Press the 'START/HOLD' button → Select the programme that you want to change. → Press the 'START/HOLD' button again.

6 Initial use

Before first use of the machine, ensure that all preparations are made in accordance with the instructions in sections “Important safety instructions” and “Installation”.

To prepare the machine for washing laundry for the first time, perform a tub cleaning (maintenance wash) procedure as outlined in the wash programme guide on page 11 of this manual.

PREPARATION

- Close all zippers, snaps and hooks to prevent them from snagging other articles.
- Remove pins, and other hard items to prevent them from scratching the machine.
- Empty all pockets, remove all items in pockets such as coins, pens and paper clips, and turn pockets inside out and brush pockets. Such objects may damage the machine and cause noise.
- Put small size clothes such as infant's socks and nylon stockings in a laundry bag or pillow case.
- Place curtains in the wash tub without compressing them. Remove curtain attachment items.
- Turn down cuffs and turn synthetic knits inside out.
- Tie strings and sashes so they will not tangle.
- Treat spots and stains before washing.
- Tough stains must be treated properly before washing. If unsure, check with a dry cleaner.
- Use only dyes/colour changers and limescale removers suitable for machine wash. Always follow package instructions.
- Wash trousers and delicate laundry turned inside out.
- Keep laundry items made of Angora wool in the freezer for a few hours before washing. This will reduce pilling.
- Laundry that has been soiled with flour, lime dust, milk powder, etc. must be shaken off before placing into the machine. Dusts and powders on the laundry may build up on the inner parts of the machine in time and can cause damage.

SORTING





Mix large and small items in each load.
 Separate heavily soiled items from lightly soiled ones.
 Separate dark colours from light colours.
 Separate colourfast items from non colourfast ones.
 Separate robust fabrics from delicate.
 Separate whites from coloured fabrics.

LOADING

Lift the washer lid.
 Arrange the articles to be washed loosely round the perimeter of the tub.
 Load evenly as an off balance load may cause unnecessary vibrations.
 Use a large load programme when washing permanent press garments. These items need more space to move than heavy items such as jeans and towels.
 Do not overload the machine as this will result in poor cleaning, increased creasing and excessive lint formation.

Correct load capacity

The maximum load capacity depends on the type of laundry, the degree of soiling and the washing program desired.

	<p>Warning: If loading of the laundry has been incorrectly done, noise and vibration problems may occur in the machine.</p>
	<p>Some water may have remained in the machine due to the quality control processes in the production of the machine. It is not harmful for the machine.</p>
	<p>Warning: Use only detergents manufactured specifically for top loader washing machines.</p>
	<p>When using detergent, softener, starch, fabric dye, bleach or limescale remover, read the manufacturer's instructions on the package carefully and follow the dosage values. Use a measuring cup if available.</p>

7 Washing procedure & programme selection

Fully automatic programmes

1. Fuzzy programme

- Used for general laundry types.
- Built in intelligence will determine the water level, the washing time, the rinsing count and the spin drying time depending on the amount of laundry.

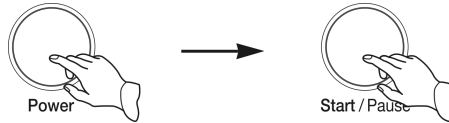

2. Eco programme (Saving)

- Economical programme to save time and water.

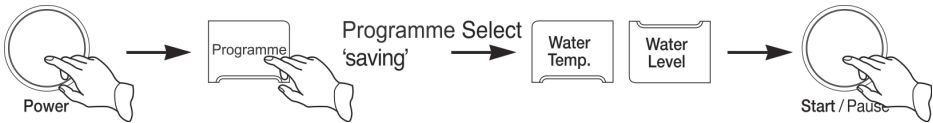

3. Delicate programme

- Used to wash sweaters, lingerie or stockings.
- Do not wash clothes marked for dry cleaning, leather or cashmere. Use neutral detergents.
- To prevent deformation, cold water and the high/med water level should only be used.



4. Blanket programme

- Used for blanket or bedding that can be washed in water.
- If you pour detergent into the cold water it may stay undissolved between the blankets. Use liquid detergent.
- Do not use it for electric blanket or carpets. (It may cause damage to the washing machine or the laundry).



5. Cotton Quick programme



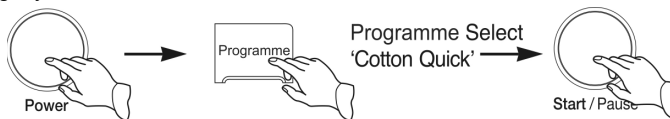

- Used for lightly soiled colourfast fabrics.



6. Tub clean

- Use the high water level for cleaning the washing tub.
- Dose the machine with a standard dose of detergent, or use 100 grams of dishwasher detergent, NOT WASHING SODA. Without loading any washing, allow the machine to run through the full cycle. Perform a tub clean once a month if the machine is used frequently.

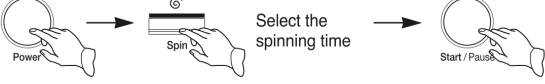
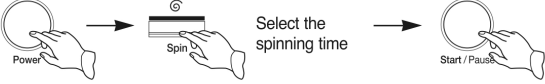

PARTIAL PROCESS	PROCEDURE OF PROCESSING
Washing Time and Soak Time Control	 <p>Select the washing time or Soak time Adjust the water level and water temperature Door (Lid) closed</p> <ul style="list-style-type: none"> • If the wash process is not required then adjust wash time to 0 minutes.
Rinsing Times Control	 <p>Select the rinsing times Adjust the water level and water temperature Door (Lid) closed</p> <ul style="list-style-type: none"> • If the rinse process is not required then adjust rinse times to 0 times.
Spinning Time Control	 <p>Select the spinning time Door (Lid) closed</p> <ul style="list-style-type: none"> • If the spin process is not required then adjust spin time to 0 minutes.
Wind Dry Time Control	 <p>Select the wind dry time Door (Lid) closed</p> <ul style="list-style-type: none"> • Use a small amount of laundry. • Wind dry also removes moisture and helps reduce drying time. • Wind dry cannot be selected with other courses.
Only Spin	 <p>Select the spinning time Door (Lid) closed</p>
Only Drain	 <p>Select the spinning time Door (Lid) open</p>
<ul style="list-style-type: none"> • After the selected process is finished, the buzzer will emit a sound. The washing machine will then be powered off automatically. • After the selected 'Only Drain' process is finished, the buzzer will emit a sound and 'LE' will be displayed on the LCD. The washing machine will NOT be powered off automatically. To power the washing machine off, close the door(lid) and press the 'POWER' button and the washing machine will power off. 	

8 Using detergents, softener & bleach

Detergent

- Add a measured amount of detergent to the detergent drawer.
- Use only detergent specifically recommended for top loading washers and follow the manufacturer's instructions.

Choosing the detergent type

- The type of detergent to be used depends on the type and colour of the fabric.
- Use different detergents for coloured and white laundry.
- Wash delicate clothes with special detergents only.
- When washing dark coloured clothes and quilts, use a liquid detergent.
- Wash woollens with special detergent made specifically for woollens.

Adjusting detergent amount

- The amount of detergent to be used depends on the amount of laundry, the degree of soiling and water hardness.
- Do not use amounts exceeding the dosage quantities recommended on the detergent package to avoid problems of excessive foam and poor rinsing.
- Use less detergent for small amounts or lightly soiled clothes.

Using softener

- Add softener into the softener dispenser before washing. The softener will flow into the inner drum in all standard programmes except the delicate programme.
- Avoid spilling undiluted softener onto the clothes in the wash tub as it may damage them.
- If the softener has lost its "fluidity", dilute it with water before pouring it into the softener dispenser.

Note: in order to avoid residual softener build up, clean the softener dispenser every 2-3 months.

How to use bleach

If required, add a measure of liquid chlorine bleach to the bleach inlet. Avoid spilling bleach onto the clothes in the machine as undiluted bleach may damage them.



1. Dilute bleach with twice the volume of water. Use only a little amount of bleach and rinse clothes well to avoid skin irritation. Do not pour bleach onto clothes.
2. Read and carefully follow the directions and warnings regarding the use of bleach.
3. Do not use bleach for coloured fabrics.
4. Do not use bleach and detergents by mixing them.

Using starch

- Add liquid starch, powder starch or fabric dye into the softener compartment.
- Do not use softener and starch together in a washing cycle.
- Wipe the inside of the machine with a damp and clean cloth after using starch.

Using limescale remover

- When required, use limescale removers manufactured specifically for washing machines only.

	When using detergent, softener, starch, fabric dye, bleach or limescale remover read the manufacturer's instructions on the package carefully and follow the dosage values. Use a measuring cup if available.
	Important: Use only detergents manufactured specifically for top loader washing machines.

9 General operating procedure

1. Adding Detergent

- 1 Use only powder detergents.
- 2 Use the correct amount of detergent according to the detergent manufacturer's instructions.
- 3 We recommend the use of detergent which is rapidly dissolved.
- 4 Do not use too much detergent. Overdosing of detergent will lead to a deterioration in the washing and rinsing performance of the washing machine.

2. Adding Softener (OPTIONAL STEP)

- 1 Pour the liquid fabric softener into the softener dispenser using the recommended amount. Avoid dripping and spilling any fabric softener directly on the clothes.
- 2 Do not exceed the base line. Over filling may cause early dispensing.
- 3 Do not pull open the detergent case when water is being supplied to the machine.
- 4 The liquid fabric softener will be dispensed into the TUB automatically during the final rinsing process.

3. Close the washer lid.

4. Press the POWER button.

5. Select the washing programme.

6. Press the START/HOLD button.

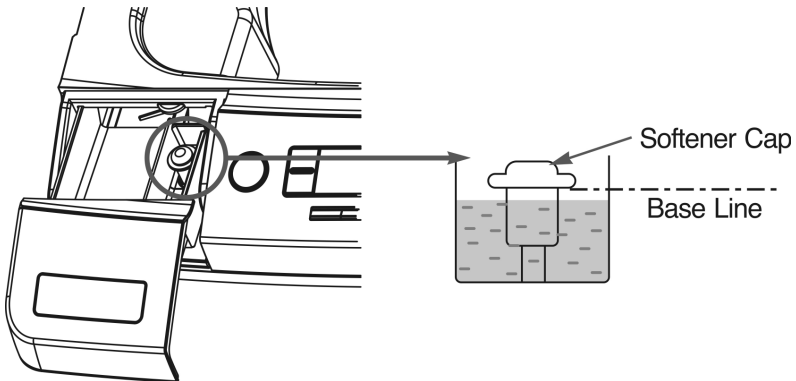

10 Cleaning the filters

Cleaning the Lint Filter.

This washer has two type of lint Filter in order to increase lint filtering performance.

Type I : Assembled in the top area of Tub

- 1 Pull the Filter frame upwards.

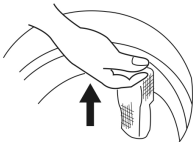

- 2 Turn the lint filter inside out, wash the lint off with water.

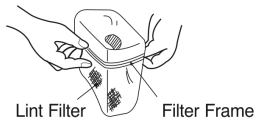

- 3 Carefully refit the filter and insert the filter frame into the slot.



Type II :

Assembled in the middle area of Tub. (Depends on model)

Clean the lint filter once every 7 days

- Remove the lint filter.
- Pull out the debris and wash the lint filter in water.
- Refit the filter. Ensure that it is correctly seated.

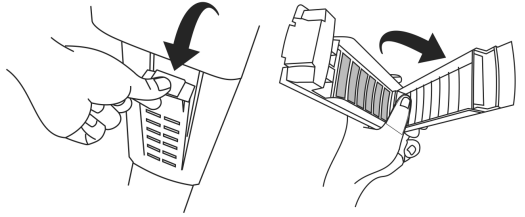

Cleaning the water filter

Clean the filter if water leaks from the water inlet.

- 1 Remove the power plug before cleaning the filter



- 2 Turn off the water supply to the washer and remove the inlet hose.

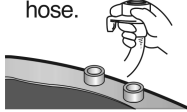

- 3 Pull the inlet filter out.

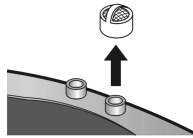

- 4 Remove the dirt from the inlet filter with a brush.

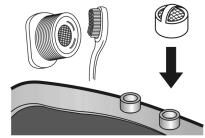

Cleaning the drain filter

- The pump drain hose filter is located on the rear side of washer.
- This drain filter screens foreign object such as threads, coins, pins, buttons, etc.
- If the drain filter is not cleaned at the correct intervals (every 10 times of use), Drainage problem could result.

- 1 Lower the hose to drain the water in the hose. Place a container under the filter to collect water.

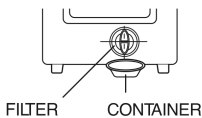

- 2 Turn the cap counter clockwise.

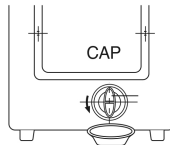

- 3 Pull out the filter assembly from the casing.

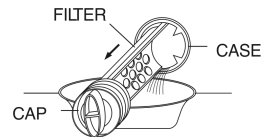

- 4 Clean the drain filter and remove any foreign objects.

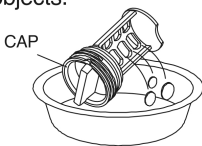

- 5 Refit the filter back into the casing. Turn the cap to adjust the flushness of the filter in relation to the hole of the casing.

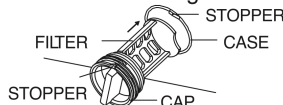

- 6 Turn the cap clockwise and firmly tighten by hand.

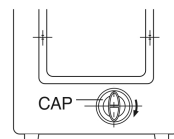

Wash programme guide

PROGRAMME	FABRIC TYPE	TEMP ° C	SELECTABLE OPTIONS
FUZZY	Colourfast garments, shirts, towels, lightly soiled cotton.	HOT, COLD HOT + COLD	WASH, RINSE, SPIN, SOAK, WIND, SPIN
ECO	Cottons.	HOT, COLD HOT + COLD	WASH, RINSE, SPIN, WIND, SPIN
DELICATE	Delicate, easily damaged laundry such as silk.	COLD	WIND, SPIN
BLANKET	Ensure that items are machine washable. (White cotton, linen, towels, sheets and blankets).	HOT, COLD HOT + COLD	WASH, RINSE, SPIN, SOAK, WIND, SPIN
COTTON QUICK	Lightly soiled colourfast fabrics.	HOT, COLD HOT + COLD	WASH, RINSE, SPIN, SOAK, WIND, SPIN
TUB CLEAN	Use to clean the tub and drum. (Run without load).	HOT, COLD HOT + COLD	WASH, RINSE, SPIN, WIND, SPIN
GYM SHOES	Running shoes and sneakers.	HOT, COLD HOT + COLD	WASH, RINSE, SPIN, WIND, SPIN
SCHOOL BAG	Rucksacks and school bags.	HOT, COLD HOT + COLD	WASH, RINSE, SPIN, WIND, SPIN
UNDERWEAR	Polyamide, Acrylic, Polyester.	HOT, COLD HOT + COLD	WASH, RINSE, SPIN, WIND, SPIN
SPORT WEAR	Lightly soiled colourfast, thin sport wear.	HOT, COLD HOT + COLD	WASH, RINSE, SPIN, WIND, SPIN

11 Technical Specifications

Technical specifications	
Model No.	DTL137
Dimension W x D x H (mm)	630 x 725 x 1070 mm
Net weight (Kg)	51
Spin Speed (rpm)	700
Water Capacity (High) (L)	100
Required water pressure	0.03~0.8MPa
Rated voltage	230-240V~50Hz
Inner Tub	Stainless Steel
Inner Tub dimensions (Diameter/H)	510/505 mm
Display	LED Display
Control Type	Micom
Wash noise	44dB
Spin noise	59dB
Colour	Silver

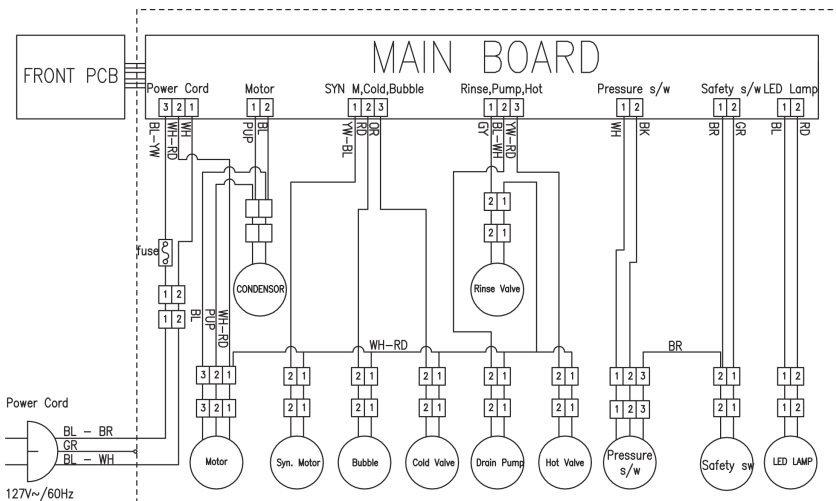

12 Owners Responsibility

SINCE THE FOLLOWING ARE NOT FACTORY FAULTS, THEY ARE THE OWNER'S RESPONSIBILITY

- Damage to the exterior finish, breakage of components, damage through improper use or installation of the washing machine or damage caused by moving the washing machine.

Before calling a Service technician or your dealer, please check the following:

- Is the machine plugged into the wall socket? Is the house circuit breaker on?
- Is the machine switched on? Has the washer lid been closed properly?
- Is the detergent dose correct? Is the filter clean? Is the tap open?
- Is there a water supply to the home? Have any of the hoses been twisted or kinked?

Things to be done for energy saving





- Always follow the instructions on the detergent packaging.
- Wash slightly soiled laundry at low temperatures.
- Use faster programmes for small quantities of lightly soiled laundry.

Disposing of the washing machine

- This washing machine has been manufactured with high quality parts and materials which can be reused and are suitable for recycling.
- **Do not dispose of the machine with normal domestic waste at the end of its service life.**
Please consult with your local authorities.
- **Should you at any time in the future scrap the washing machine, cut the power cord and take measures to render the door inoperative thereby preventing children, when playing, getting trapped inside.**

	<p>Ensure parts and accessories are Installed according to the directions given in this instruction manual.</p>
	<p>The manufacturer strives for continuous improvement. For this reason, technical specifications, text and illustrations in this manual are subject to change without notice.</p>
	<p>Figures in this manual are schematic and may not match your machine exactly.</p>

13 Trouble shooting

Problem	Problem indicator	Where to Check
The machine does not work at all.		<p>Check the POWER ON/OFF button. Check the START/PAUSE button. Check that the power cord is securely plugged in. Check whether there has been a power failure. Check whether there is blown fuse or tripped circuit breaker.</p>
<p>Water does not flow into the wash/spin tub. If the water supply to the machine is not finished within 20 minutes, the indicator lamp will light up and the buzzer will sound to indicate a problem.</p>		<p>Check whether the tap is open. Check to see if the water supply has been cut off. Check whether the metal filter in the inlet filter is clogged. Check to see that the water pressure is not too low. Check that the height of the drain hose is above 860 mm.</p>
<p>Water does not drain. If the draining is not finished within the selected time, the indicator lamp will light up, and the buzzer will sound to indicate a problem.</p>		<p>Check that the height of the drain hose is not above 1300 mm. Check that the drain hose is not kinked or obstructed. Check to see if the drain hose is too high off the ground. Check to see if the water outlet is clogged.</p>
<p>The machine does not spin. If the clothes are clumped to one side during spinning the tub will become unbalanced and the spin operation will then be Interrupted. The unbalanced condition will be corrected by the following operation: WATER SUPPLY →RINSE →DRAIN. If the unbalanced condition is unchanged despite repeating the above operation, the lamp will light up, and the buzzer will sound to indicate a problem.</p>		<p>Check to see that the laundry is evenly distributed and that it has not clumped on one side of the wash/spin tub. Check whether the washer is on a level surface. Close the washer lid. Ensure the lid is not being obstructed from closing. If the lid is open,  will light up</p>
Other problems.		<p>Press the POWER ON/OFF button to turn off the power. Call your nearest DEFY service agent or your dealer.</p>

The following conditions are normal to the operation of the washing machine and are not faults:

- An operating sound heard during water supply made by the water inlet valve.
- An operating sound from the tub auto balancer when the tub is stopping.
- An operating sound heard during wash or spin is made by the air bubble generator.



Warning: If the problem cannot be eliminated, even after the instructions have been followed, consult with your dealer or Authorized Service Agent. Never try to repair a non functional machine yourself.

14 Service Centres

BLOEMFONTEIN 160 Long Street, Hilton,
Bloemfontein 9301.
Tel. 051 400 3900
Bloemfontein.Service@defy.co.za

CAPE TOWN 5A Marconi Rd.
Montague Gardens, 7441.
Tel. 021 528 3000
CapeTown.Service@defy.co.za

DURBAN 35 Intersite Avenue,
Umgeni Business Park, Durban 4051.
Tel. 031 268 3300
Durban.Service@defy.co.za

EAST LONDON 16 Bowls Rd. Arcadia,
East London 5201.
Tel. 043 743 7100
EastLondon.Service@defy.co.za

JOHANNESBURG Cnr. Mimetes & Kruger Sts. Denver ext.12
Commercial Head Office,
Administration, Distribution, National Groups,
Tel. Sales, Contracts and Credit. Johannesburg. 2094.
Tel. 011 621 0200 or 011 621 0300
Gauteng.Service@defy.co.za

POLOKWANE 87 Nelson Mandela Drive.
Superbia 0699.
Tel. 0152 92 1166 / 7 / 8 / 9.
Polokwane.Service@defy.co.za

PORT ELIZABETH 112 Patterson Road,
North End, Port Elizabeth 6001.
Tel. 041 401 6400
PortElizabeth.Service@defy.co.za

PRETORIA. Block A1 Old Mutual Industrial Park.
Cnr. D.F.Malan Drive & Moot Str.
Hermanstad. 0082.
Tel. 012 377 8300
Pretoria.Service@defy.co.za

**OTHER AREAS ARE SERVICED BY OVER 200 AUTHORISED AGENTS. FOR FURTHER
DETAILS PLEASE CONSULT THE NEAREST REGIONAL DEFY TECHNICAL SUPPORT
CENTRE**

15 Warranty

This certificate is issued by DEFY APPLIANCES LIMITED manufacturers of Defy and Ocean products, hereinafter the Company, to the original purchaser only, of the appliance described on the certificate and shall constitute the only warranty given in respect of this appliance.

The Company warrants to the original purchaser that for a period of TWO YEARS from date of purchase the appliance is free from defect under normal domestic use, both in workmanship and material, subject to the following conditions.

1. Repair or replacement of any part of this appliance, found by the Company to be defective, shall be at the election of the Company. The Company reserves the right to effect such service through any of its Service Divisions or Authorised Service Dealers. The cost of such service shall be borne by the Company in full, provided that the appliance is located no further than 50km from a Company Service Centre or an Authorised Service Dealer. Where the appliance is located beyond the 50km radius, the purchaser shall be liable for the standard travelling charges, as determined by the Company.
2. Vitreous enamelware, fuses and lamps are specifically excluded from these warranties. It is an express condition of these warranties that the purchaser takes due care and attention in the use and maintenance of the appliance. Abuse, misuse in conflict with operating instructions, connection to incorrect voltages and subjection to commercial use shall release the Company from its obligations.
3. This warranty shall become void and cease to operate if the appliance is dismantled by, or any repairs to the appliance are effected by any persons not duly authorised by the Company, or if substitute parts not approved by the Company are used in the appliance, or if the serial number of the appliance is removed.
4. The Company shall not be responsible for damages resulting from fire, flood, civil disturbances or any Act of God. The Company shall not, in terms of these warranties be responsible nor held liable for any consequential loss or damage of any kind caused by or due to the failure or malfunction of the appliance.
5. The Company shall not be responsible for transportation or other costs other than those incurred within the provisions of Point 1 of this Certificate.
6. These warranties shall not apply to the appliance if it is purchased or used beyond the borders of the Republic of South Africa, Namibia, Botswana, Swaziland and Lesotho.
7. Where service is requested under warranty and no fault or defect can be found by the Company, all costs incurred will be for the purchaser's account.
8. This Certificate as well as your invoice will serve as proof of purchase. For the purpose of warranty, it will be essential to produce this Certificate and invoice. Failure to do so, will render the purchaser liable for service costs.

**KEEP THIS CERTIFICATE AND SALES INVOICE AS
PROOF OF PURCHASE FOR WARRANTY PURPOSES.**